

TOPICS

Fundamentals

Structured and Object-Oriented Analysis

Formal and Automated Techniques

Data Flow Analysis Methods

 **Data Flow Diagrams**

 **Data Dictionary**

Data Flow Diagrams

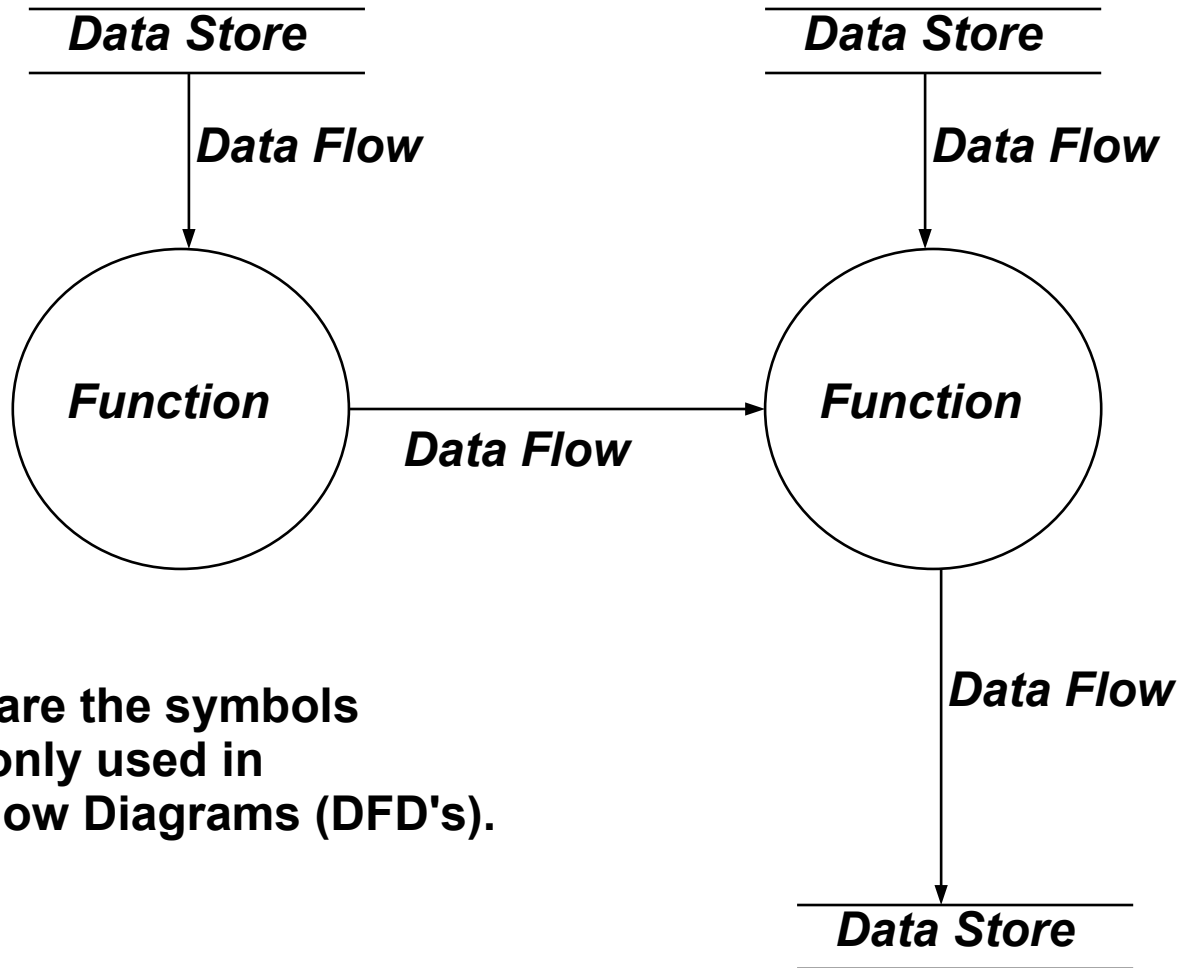

These are the symbols commonly used in Data Flow Diagrams (DFD's).

DFD Example

Simple Printed Circuit Board Layout Program

Given two data files: a list of nets and initial board description,

- 1. Determine and display the best route for interconnecting each net on the board.**
- 2. Permit user to:**
 - a. add new nets to list**
 - b. delete nets from list**
 - c. select any or all nets to be routed**
 - d. request status info about nets or routed board**
 - e. define style of routing (steiner points, chain, or tree)**
 - f. save final routed board in a file**

DFD Example, Continued

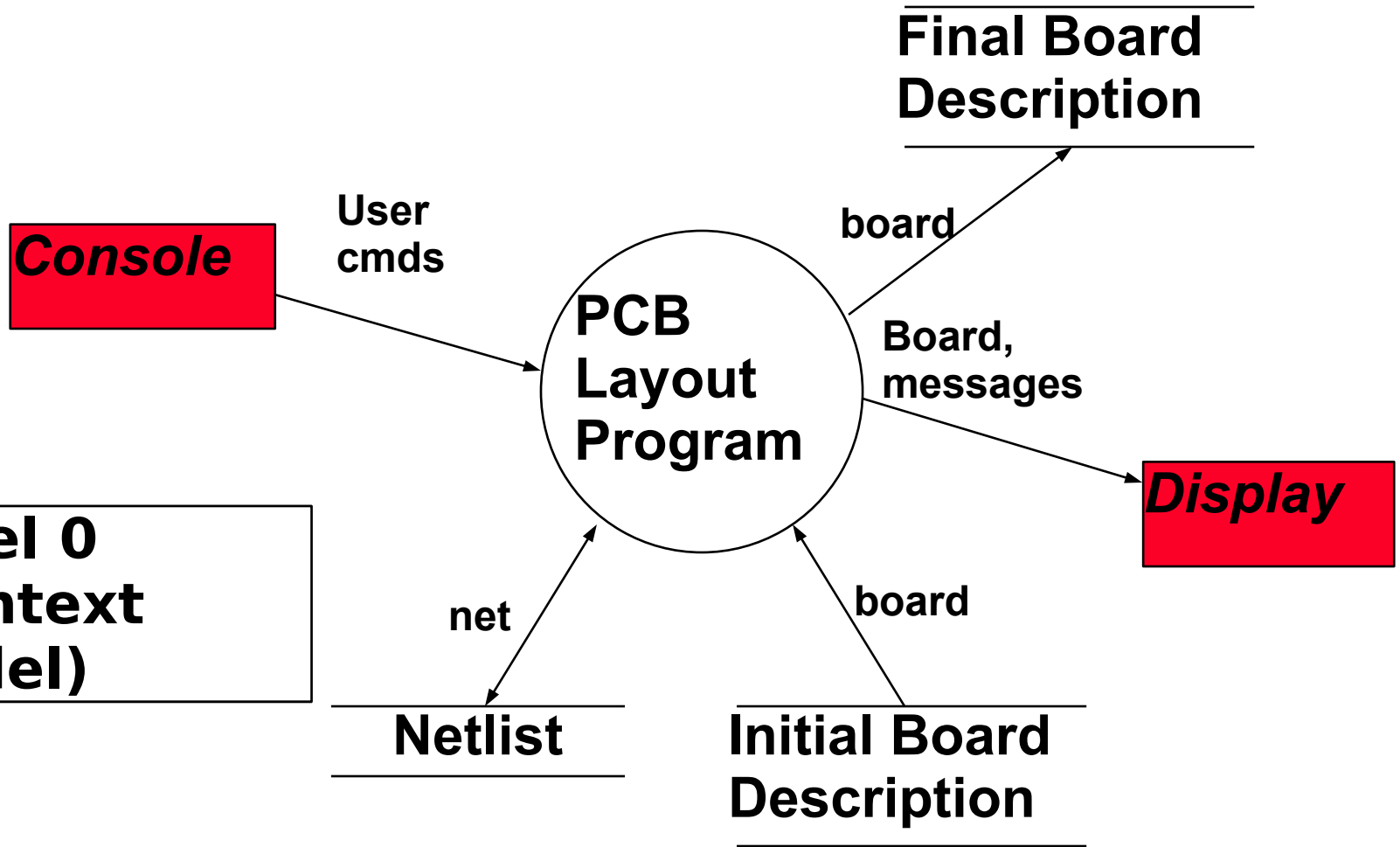

**Level 0
(Context Model)**

DFD Example, Continued

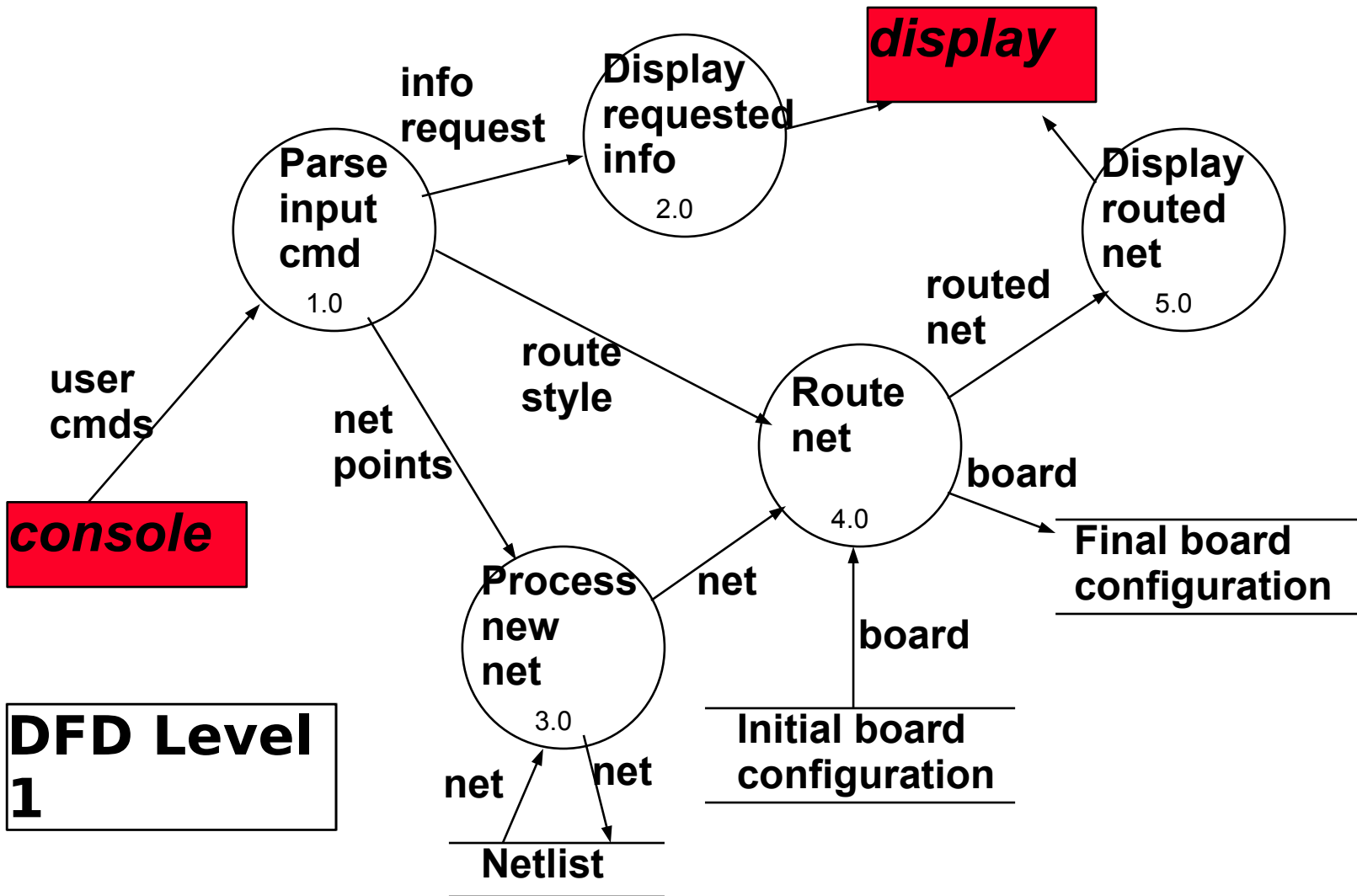

DFD Level 1

DFD Example, Continued

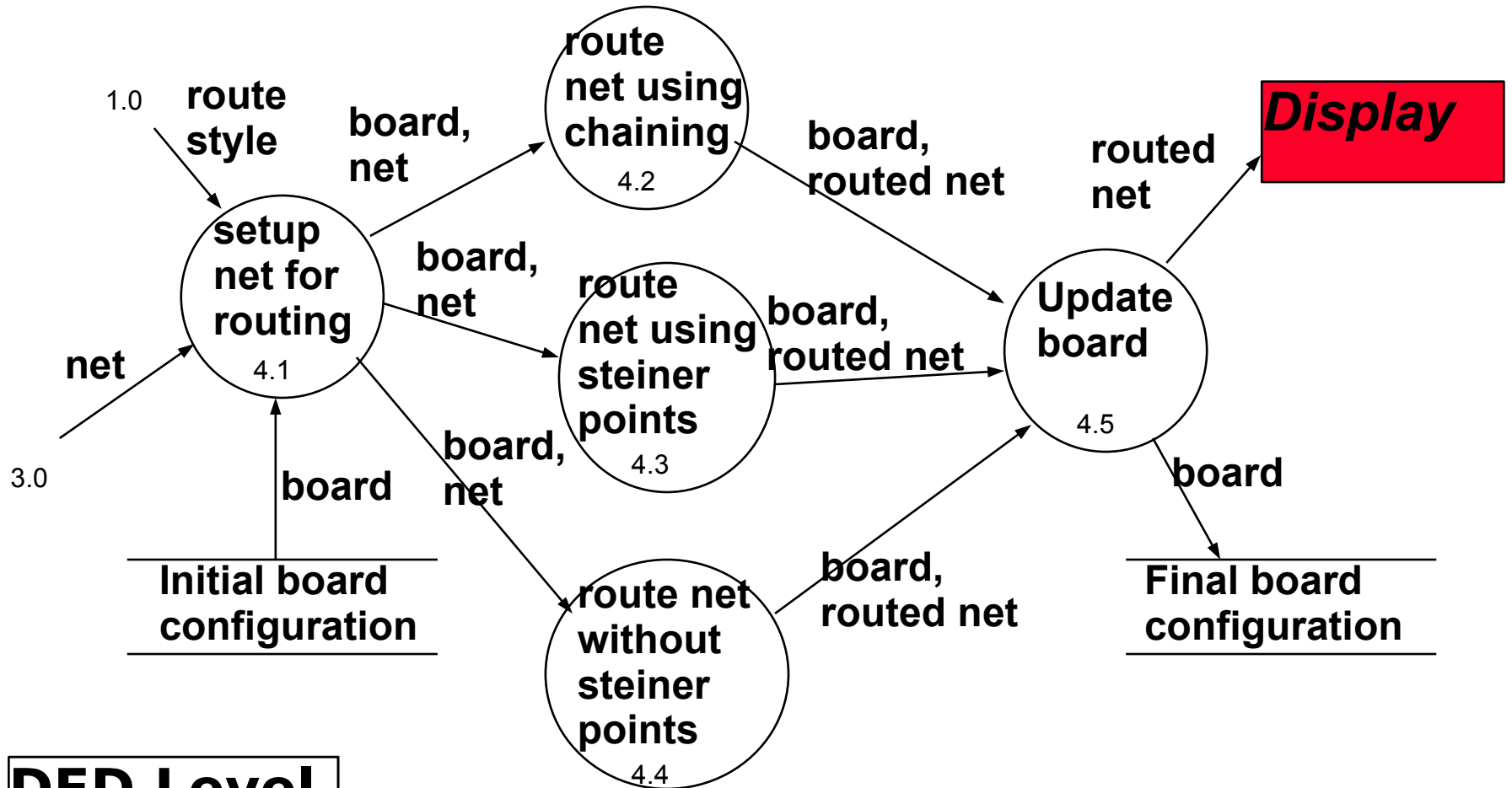

DFD Level 2

Data Dictionary and Its Content

- Each class of objects in the system and its attributes**
- Each singular object (i.e., if placed into a class, the class would have only one instance) and its attributes**
- Key constants and their attributes**
- Subprogram parameters and their attributes**

Data Dictionary Entry (Example)

Name: **net**

Alias: **net_graph, point_list**

Used: **process in out file buffer external**

4.1 3.0 4.2,4.3,4.4

4.2 4.1

4.3 4.1

4.4 4.1

Description: **List of no more than 20 points (x,y) where x and y are vertical and horizontal grid locations on the board. x and y are 16-bit unsigned integer values each greater than 0 and less than the max size of the board.**

Supplementary Information: **-- none --**

Functional Analysis Methods

 **Function Diagrams**

 **State Transition Diagrams (STD's)**

 **Entity-Relationship Diagrams (ERD's)**

Function Diagrams

IF-THEN-ELSE

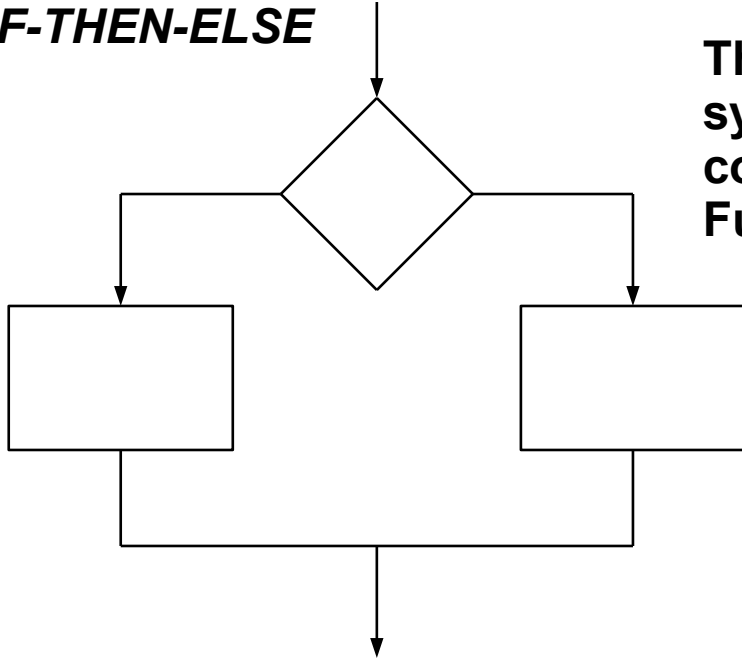

These are the symbol combinations commonly used in Function Diagrams.

CASE

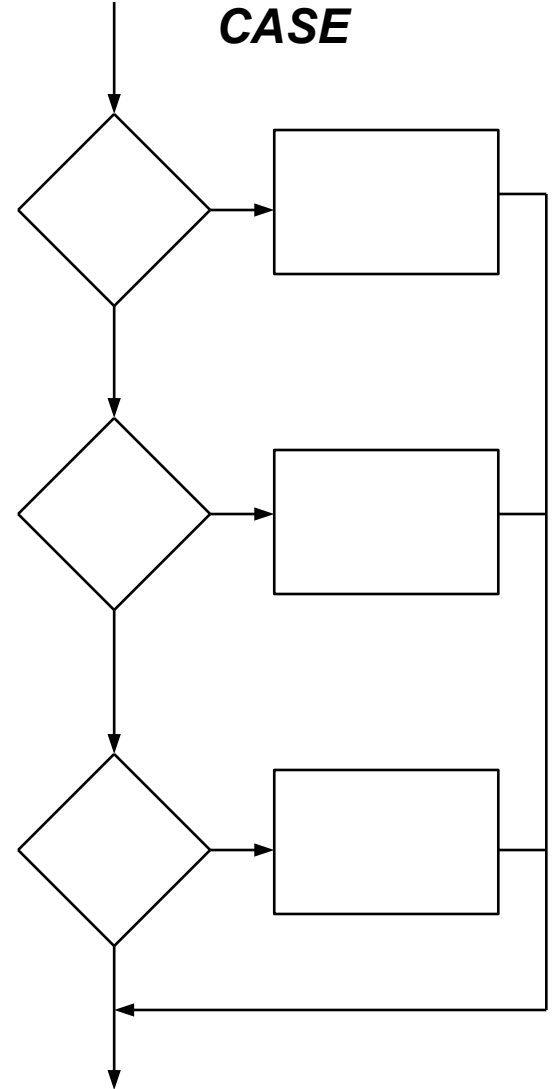

WHILE-DO

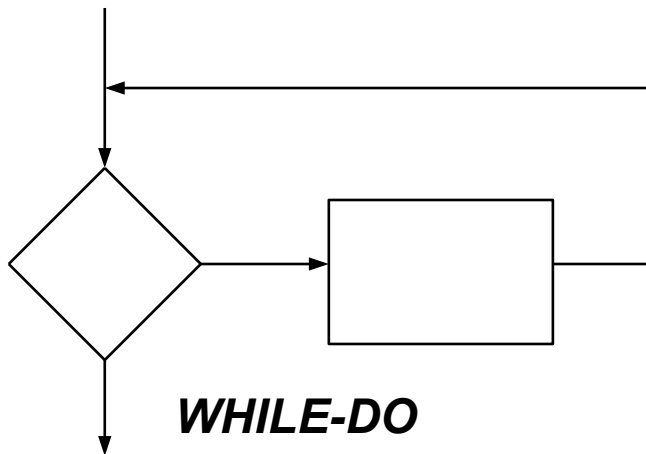

REPEAT-UNTIL

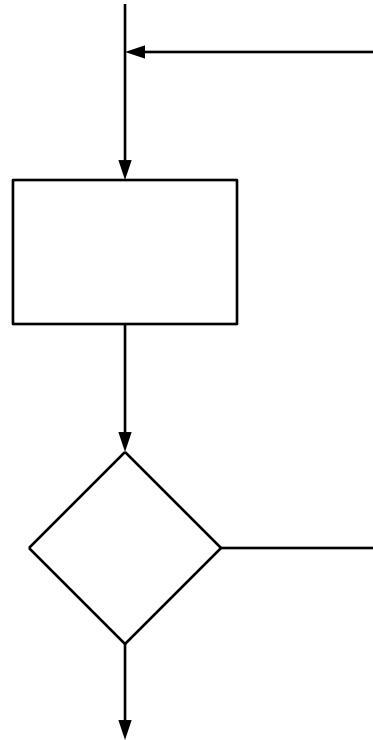

Function Diagrams - Example

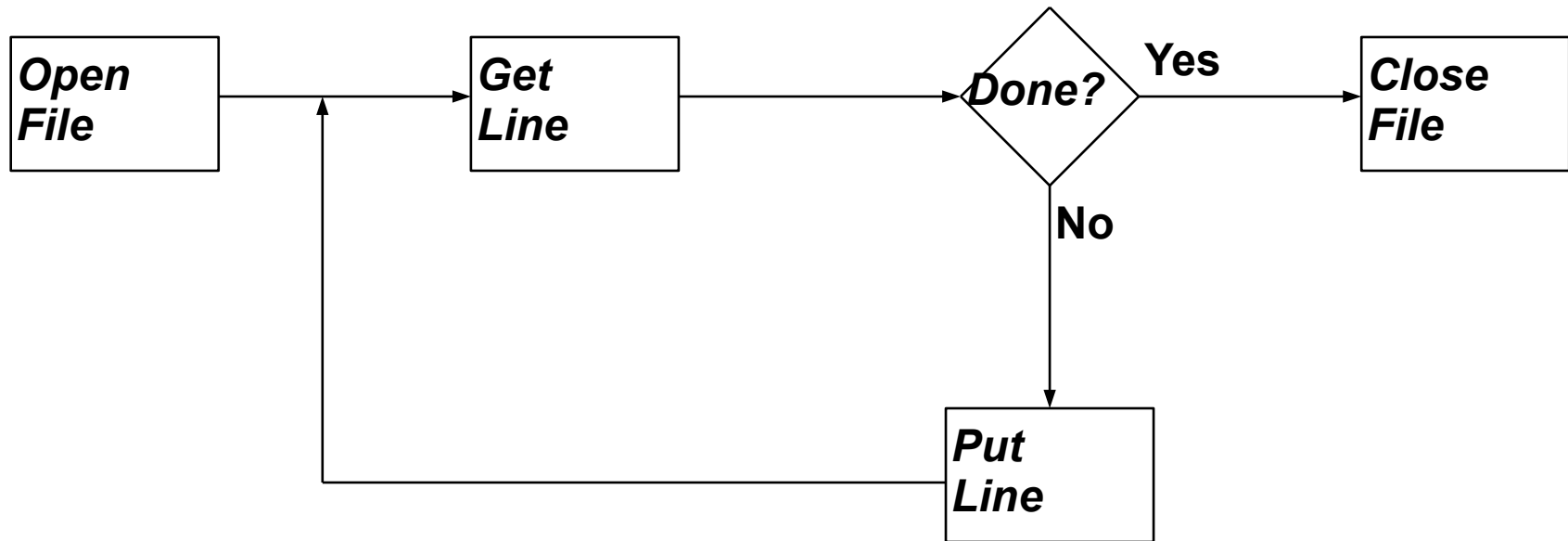

Behavioral Modeling

- **Helpful for control-dominated systems**
- **State Transition Diagrams**
 - **Like Finite State machines**
 - **Depicts states and events causing change of state**
 - **Depicts actions to be taken when events received**

State Transition Diagrams

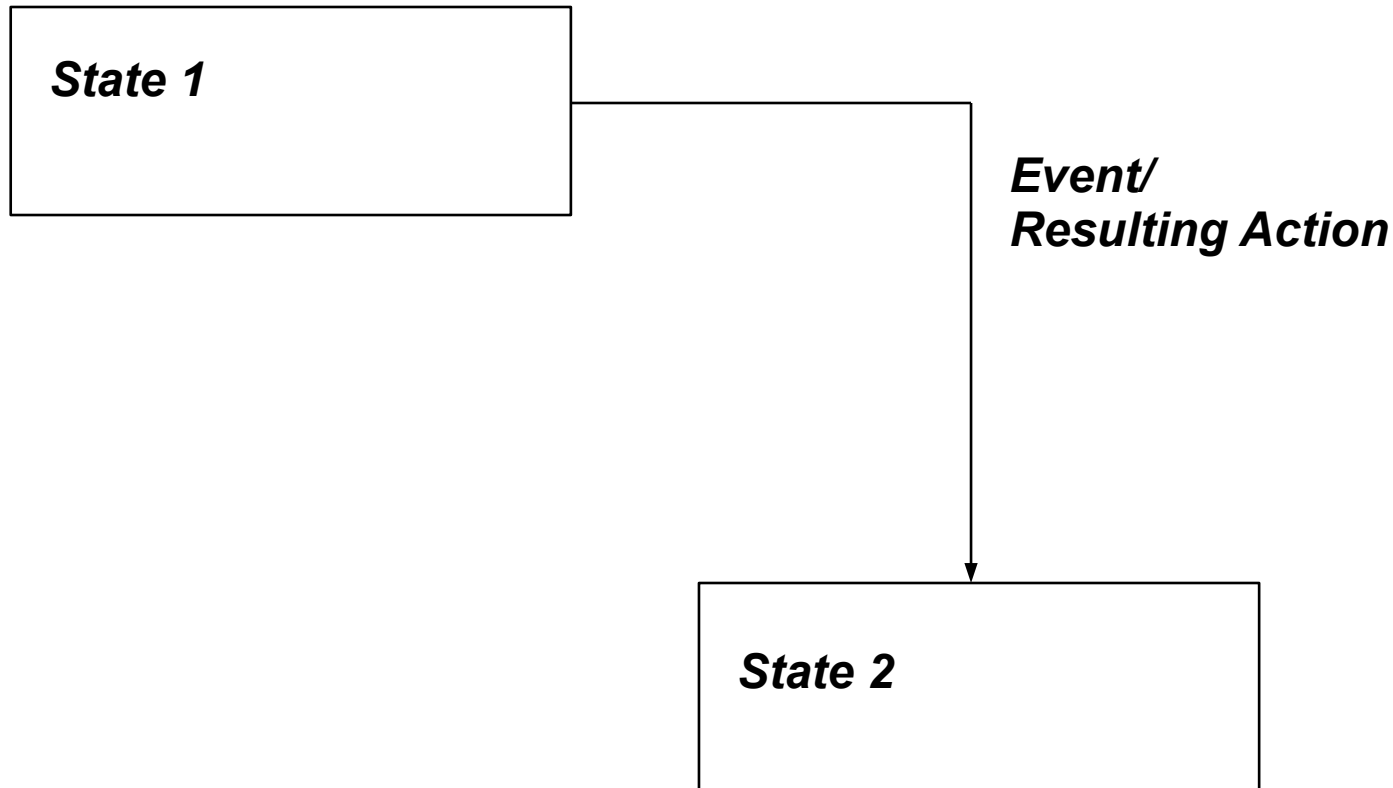

**These are the symbols
commonly used in
State Transition Diagrams (STD's).**

State Transition Diagrams - Example

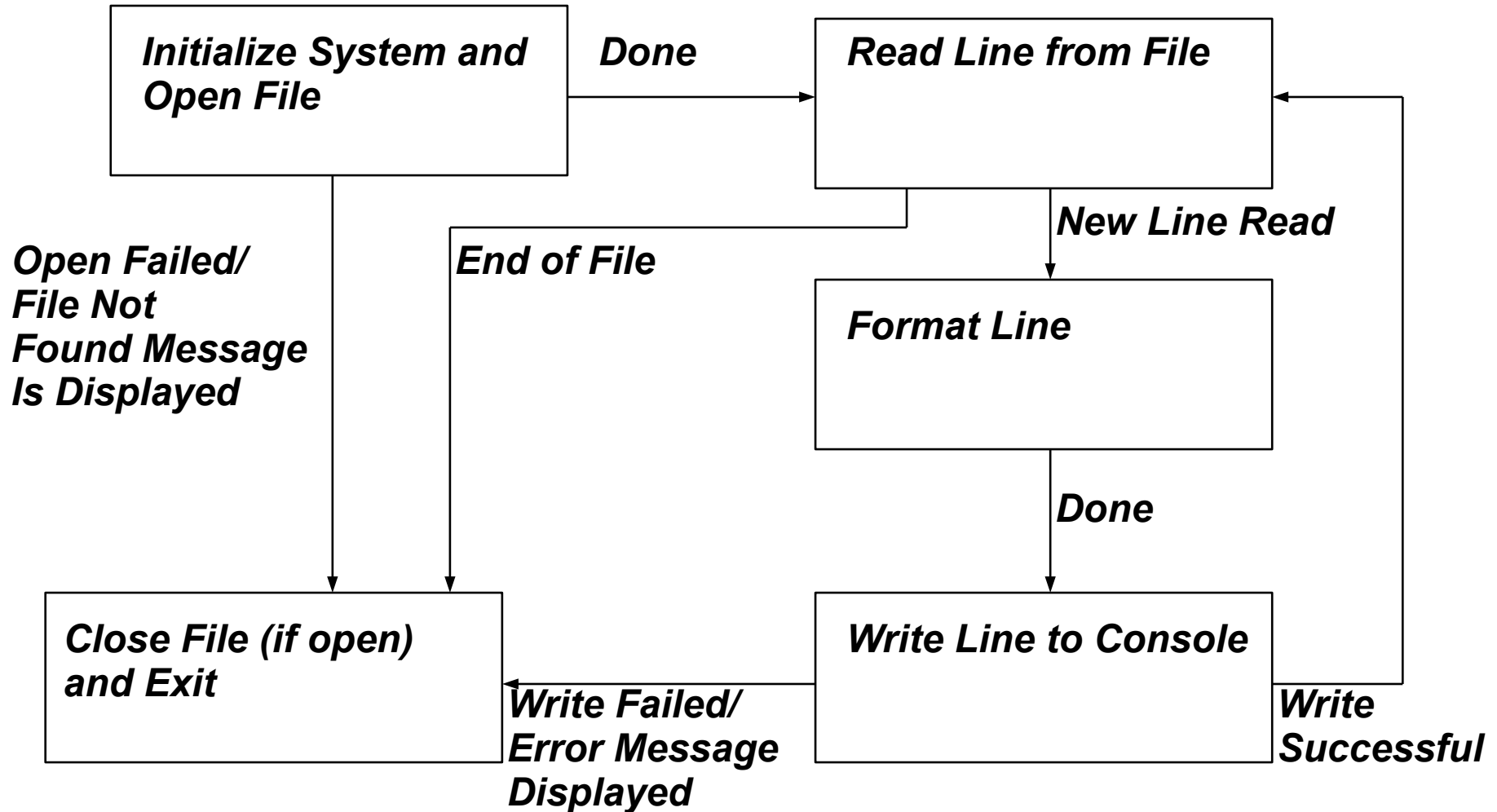

SRA for Real Time Systems

- ***Real Time Systems:***
 1. Time dependent
 2. Control oriented
 3. Driven by events more than data
 4. Some activities execute asynchronously

- Use control flow models to specify such systems

- Approach: Extend DFD model

Ward-Mellor Extensions

Time Continuous Data Flows

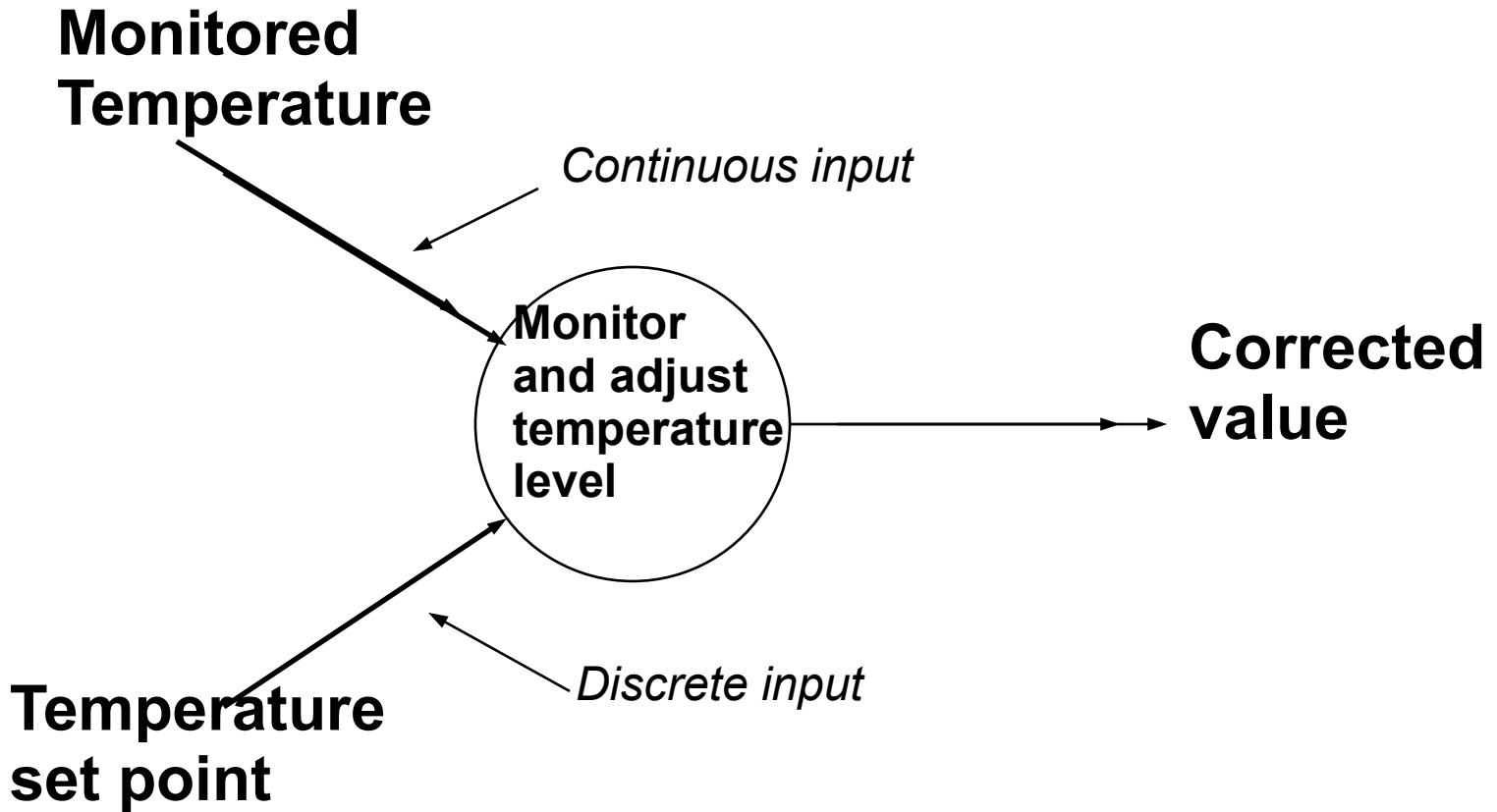

Ward-Mellor Extensions, Continued

Data and Control Flow

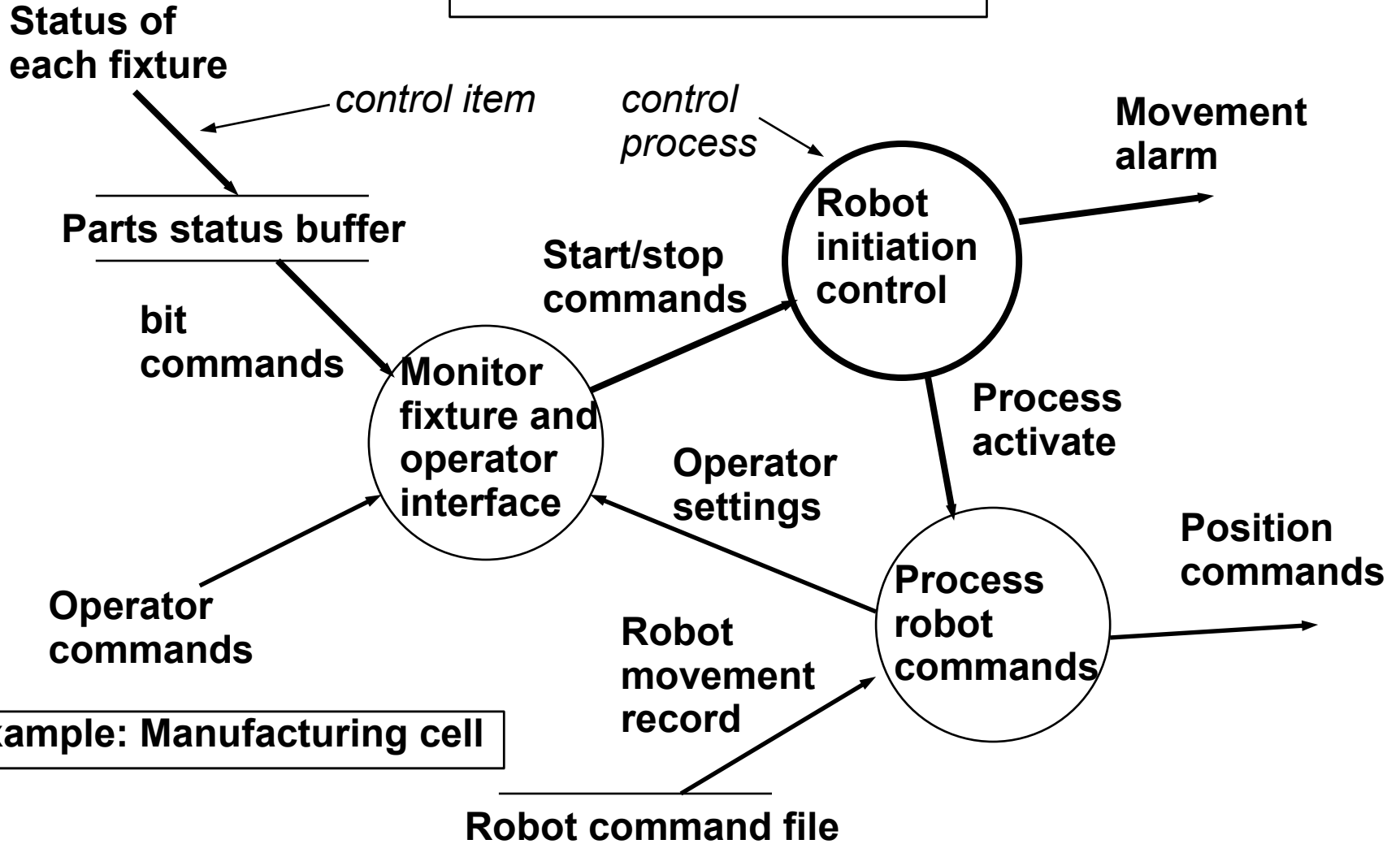

Example: Manufacturing cell

Hatley-Pirbhai Extensions

Combined Data Flow and Control Flow

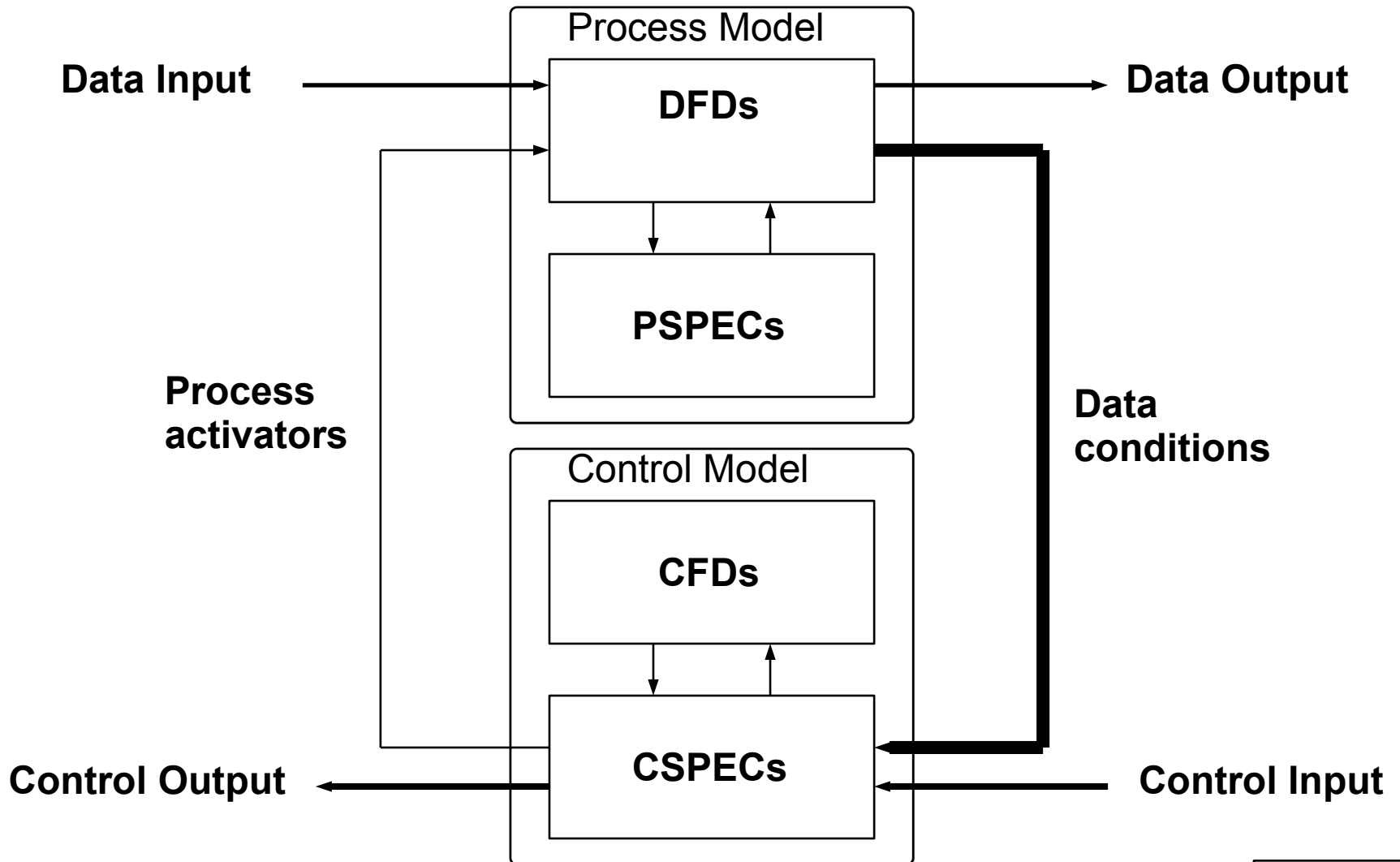

Hatley-Pirbhai Extensions, Continued

Example: Office Photocopier Software

DFD

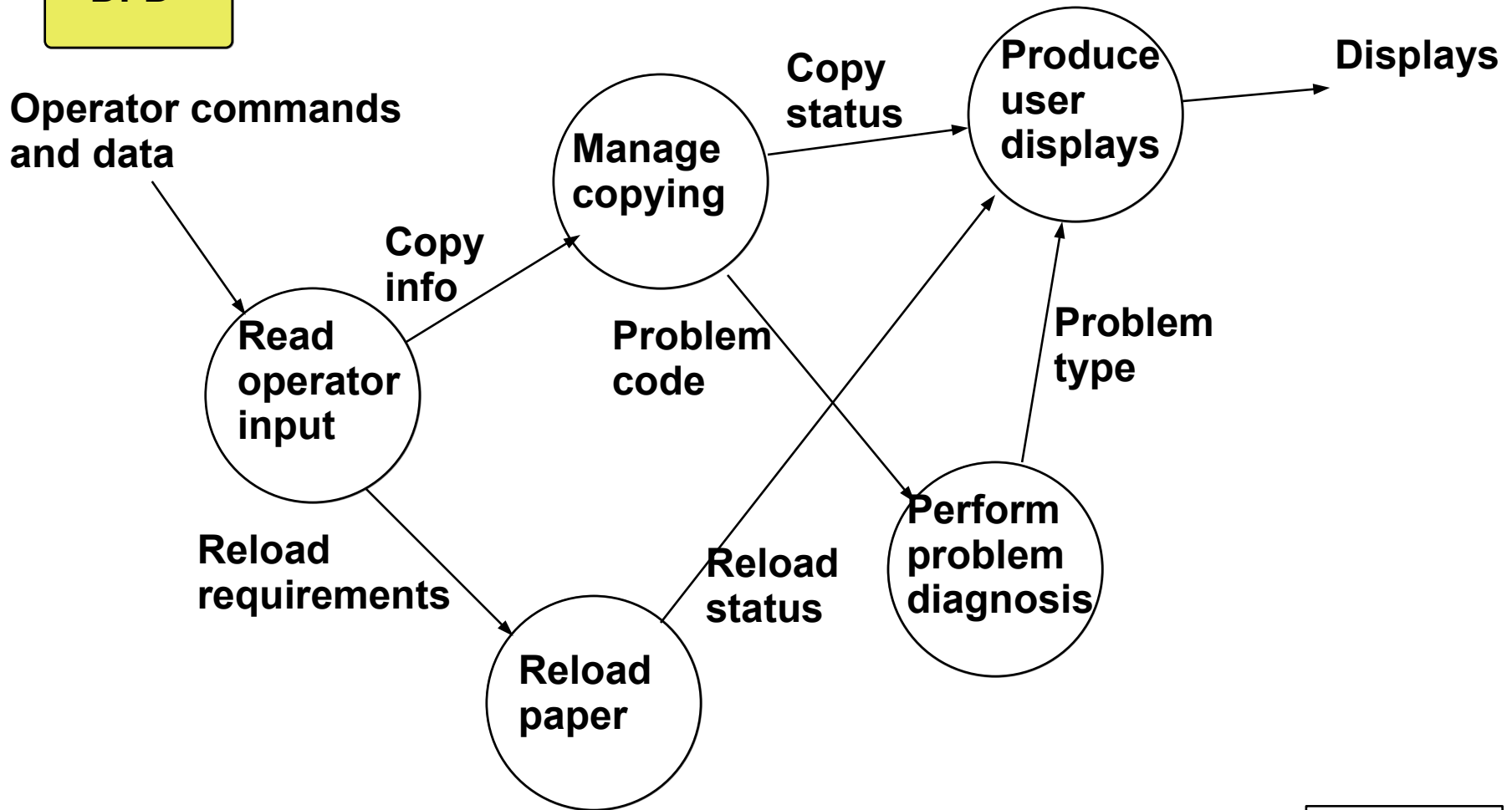

Hatley-Pirbhai Extensions, Continued

CFD

Example: Office Photocopier Software

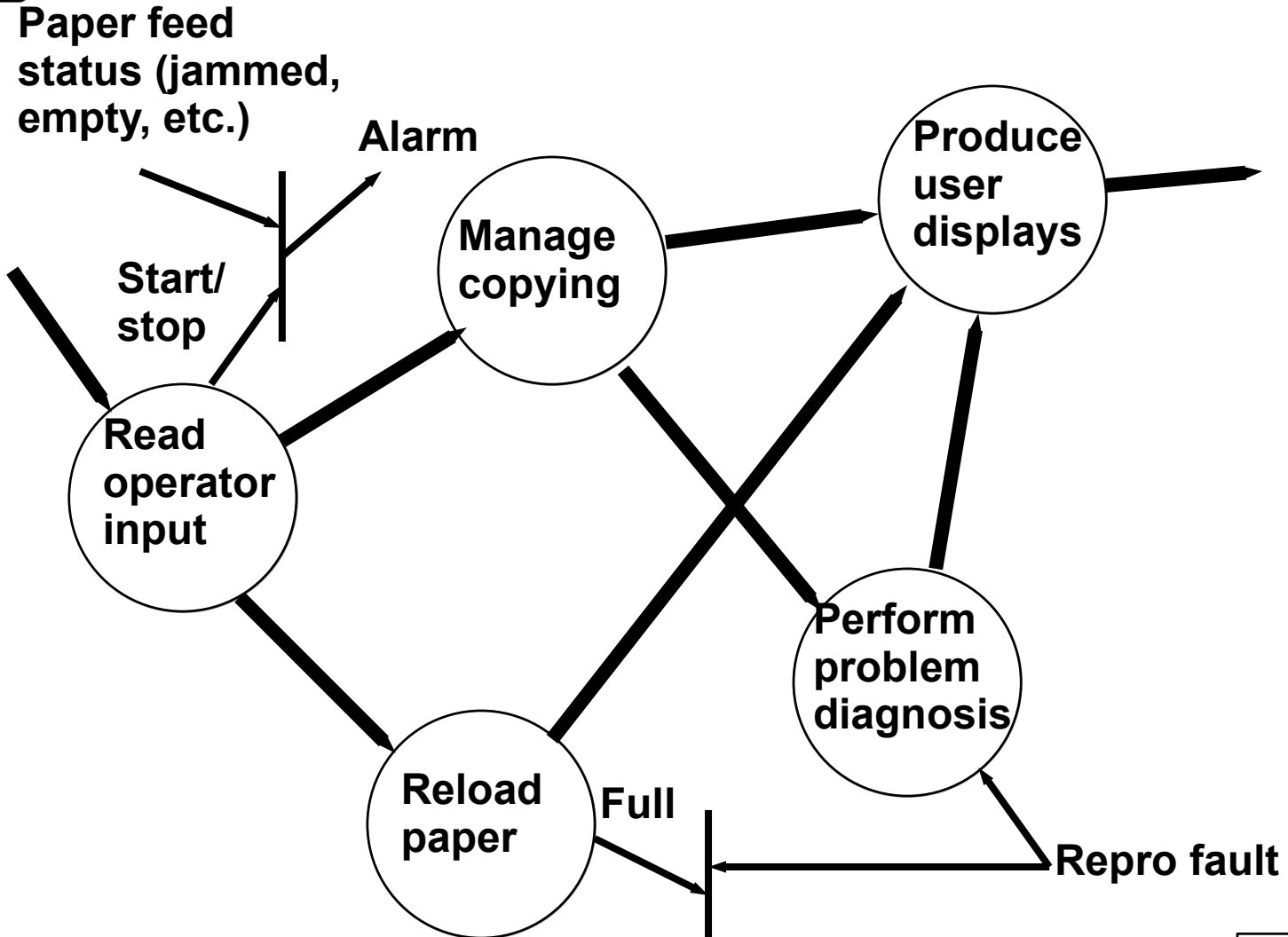

Hatley-Pirbhai Extensions, Continued

Example: Office Photocopier Software

PSPEC

Read Operator Input:

```
if op_in = paper11
    then set form=11 inches;
if op_in = paper14
    then set form=14 inches;
if op-in = color
    then set style=colortype;
.
.
.
```

CSPEC

Alarm Condition:

```
if start && (feed_status = NOT
    ok) then set alarm (status);
.
.
.
```

An Alternative: SADT¹

Structured Analysis and Design Technique
(also known as IDEF 0)

- A graphical notation
- Actigrams and datagrams that communicate relations of information (data and control) and function within software
- Includes project control guidelines for applying methodology

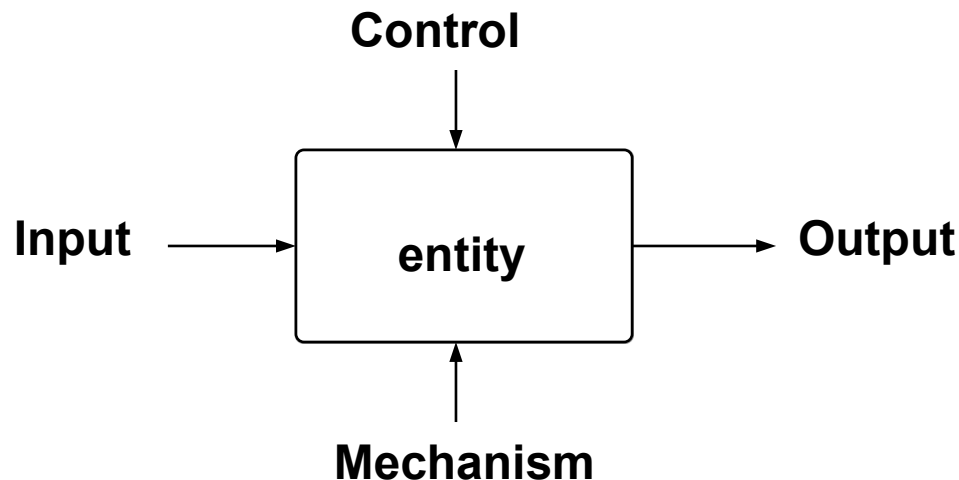

¹ Trademark of Softech, Inc.

SADT, Continued

Actigrams and Datagrams

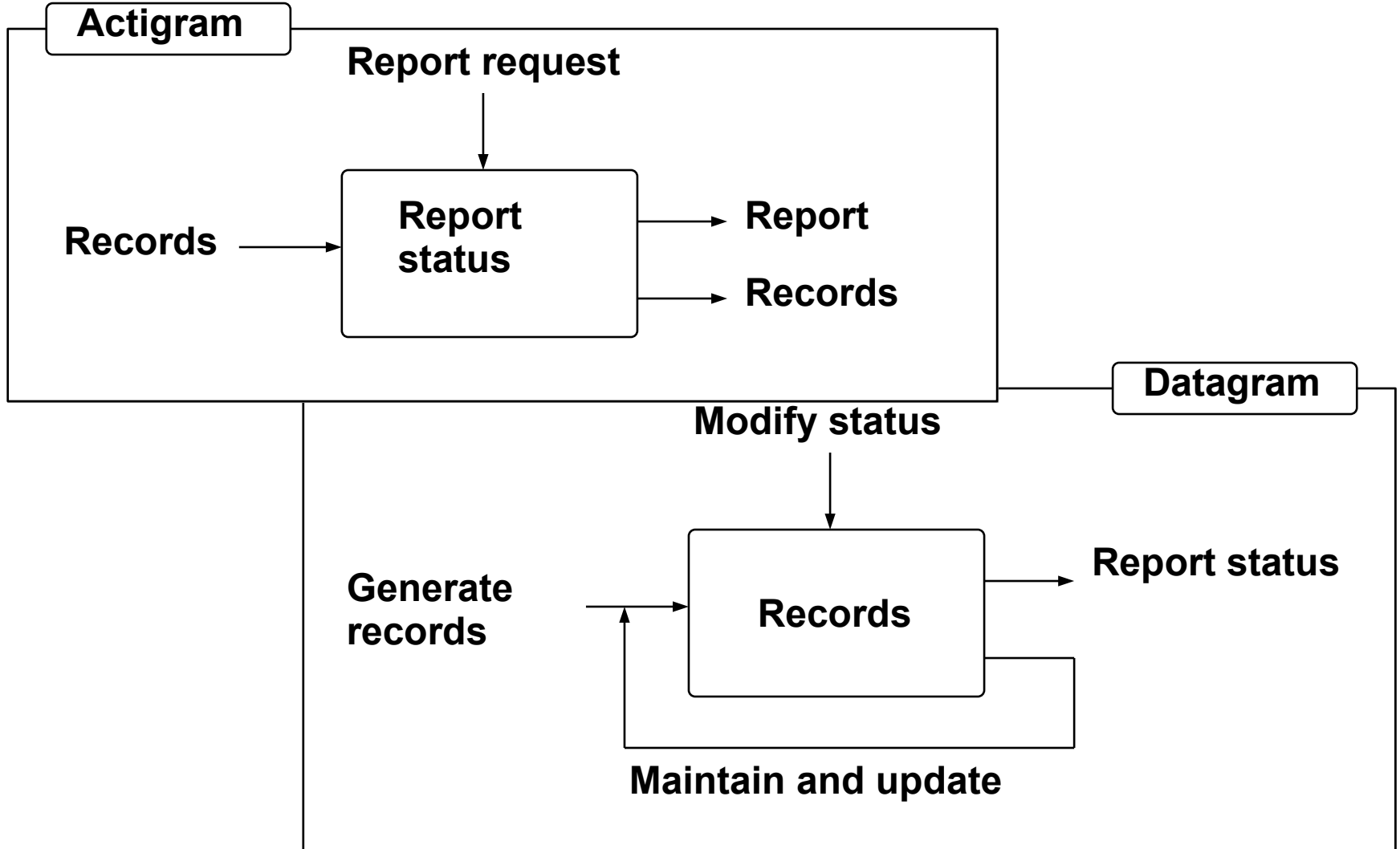

SADT, Continued

Example: Spelling Checker

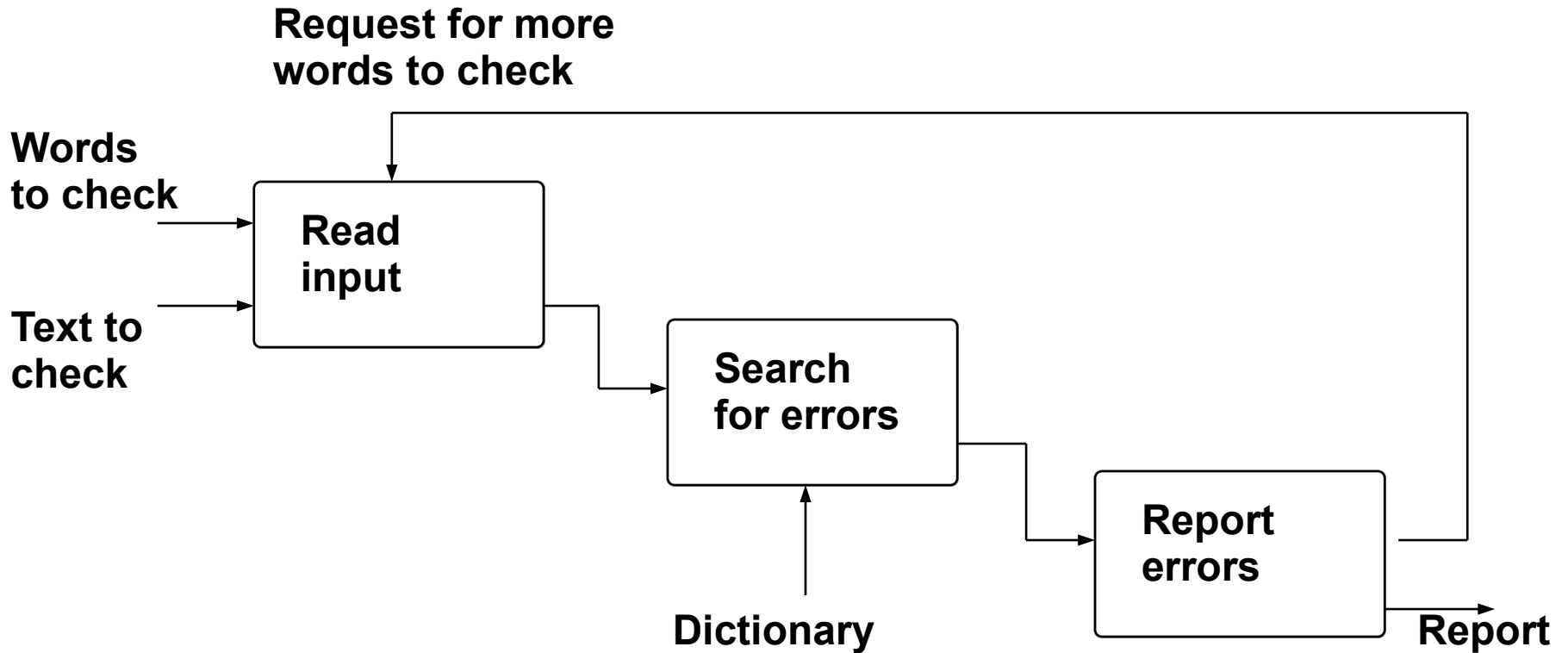

OOA: Object Oriented Analysis

- **Basic concepts**
- **How to identify objects**
 - **Identifying objects**
 - **Specifying attributes**
 - **Defining Operations**
 - **Communication between objects**
- **OOA modeling**
 - **Classification and assembly structures**
 - **Defining subjects**
 - **Instance connections and message paths**
 - **Prototyping**
- **Data Modeling**
 - **Data objects, attributes and relationships**
 - **E-R diagrams**

Basic Concepts

Object Oriented Development Process

Given a clear and complete statement of problem definition:

**Identify
Objects**

**Identify
Structures**

**Define
Subjects**

**Define Attributes
and instance
connections**

**Define Operations
and Message
Connections**

Coad, P., and E. Yourdon, *Object Oriented Analysis*,
Prentice-Hall, 1990.

Basic Concepts, Continued

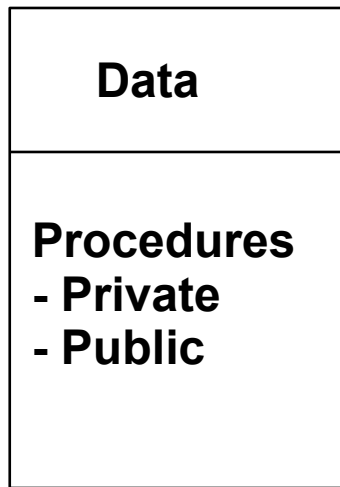

Object

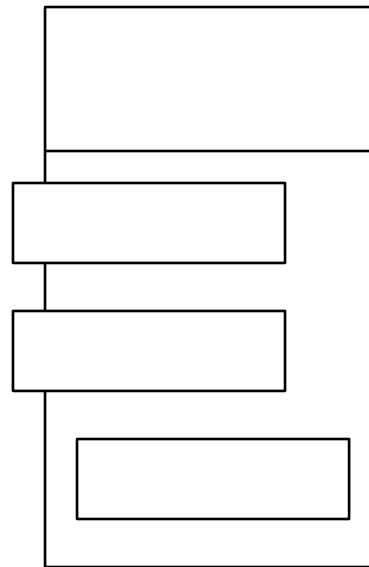

Booch Diagram
of an object

Public procedures

Private procedure

Objects are specific instances of classes (i.e., templates)

Basic Concepts, Continued

Objects are specific instances of classes (i.e., templates)

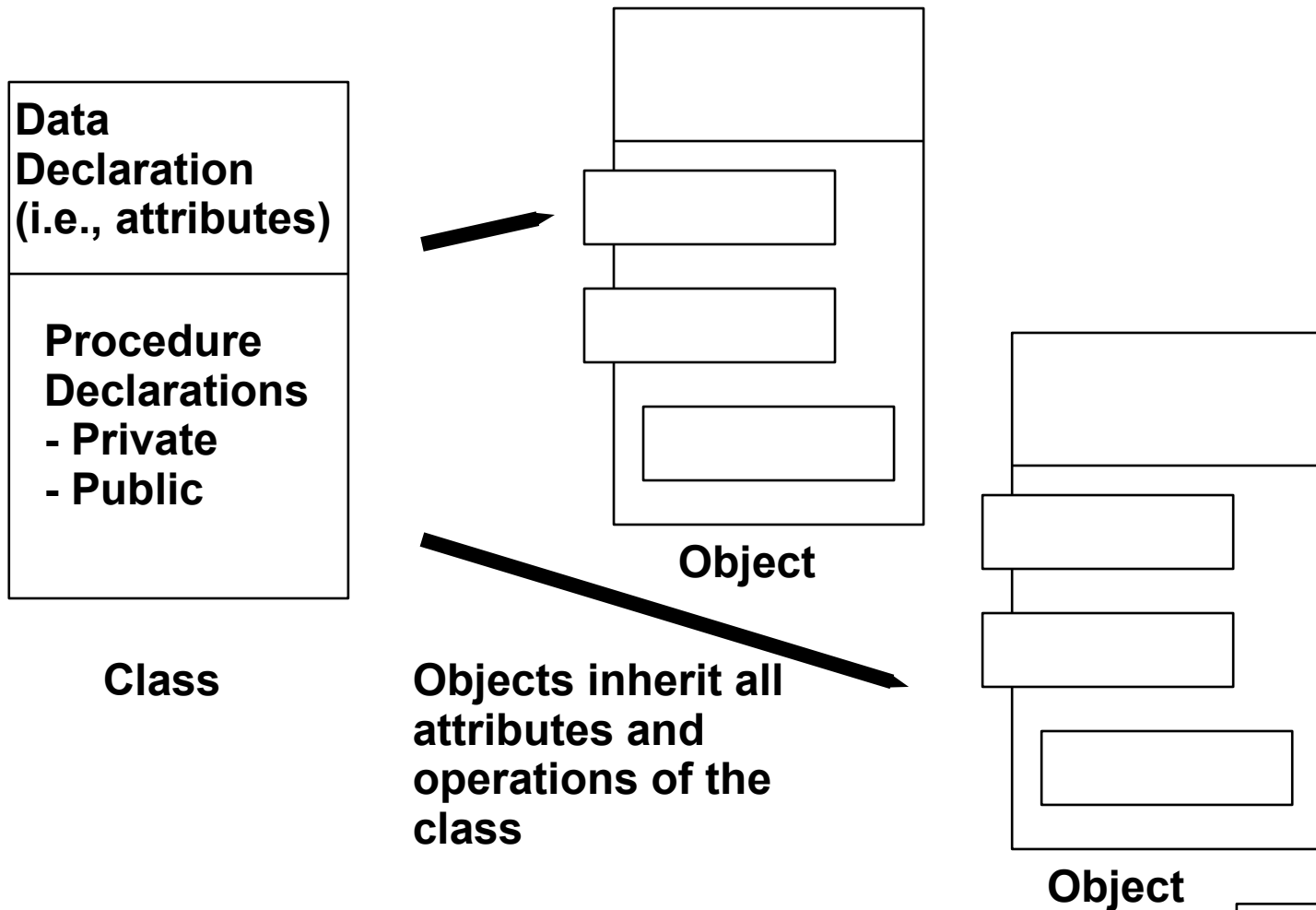

Basic Concepts, Continued

Class/object Example

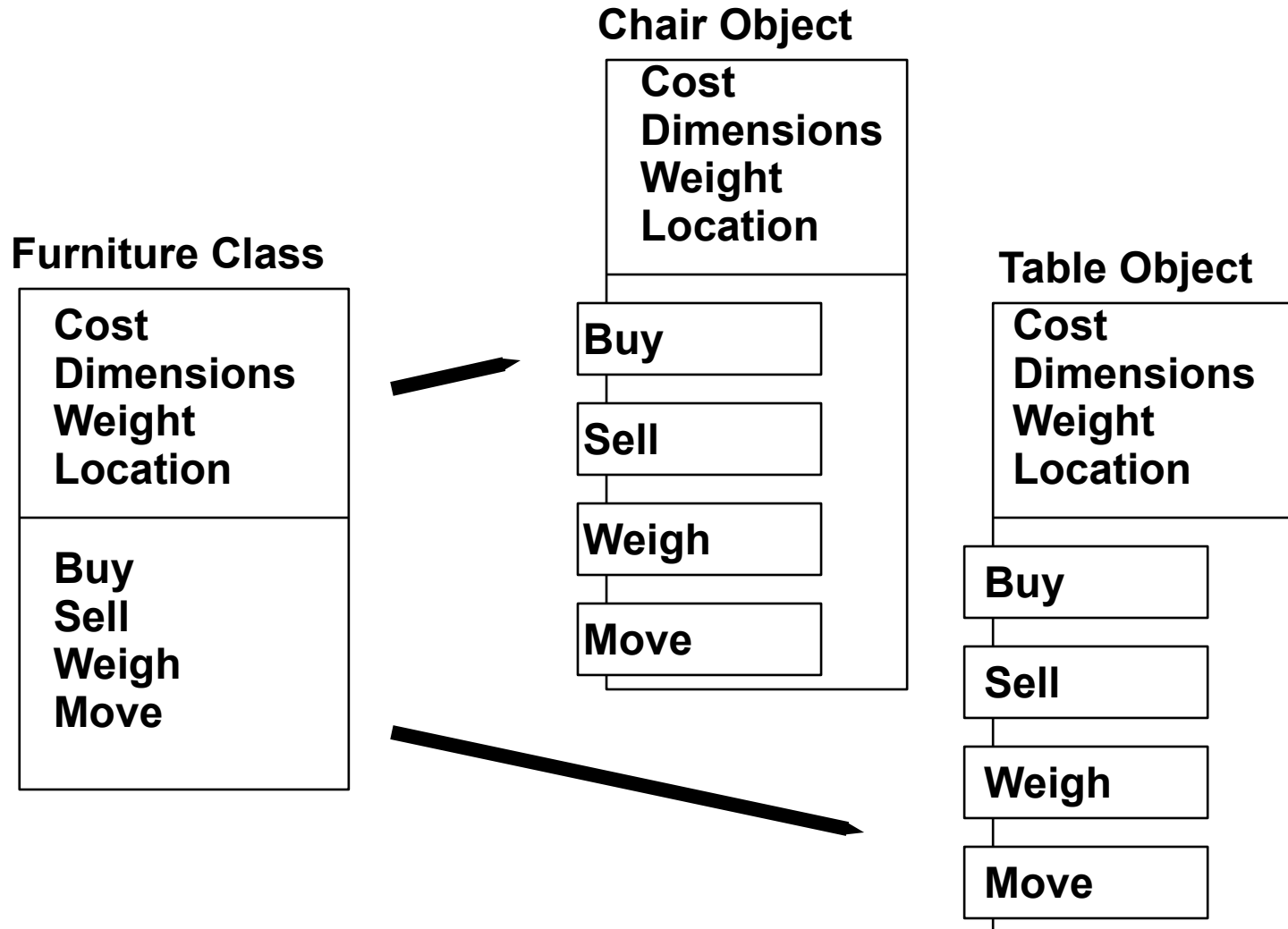

Basic Concepts, Continued

- **Encapsulation** - All class information is contained under one name which can be reused as one specification or program component.
- **Inheritance** - Objects and derived classes inherit all attributes and operations from their class descriptions.
- **Polymorphism** - Derived classes can add, delete, and redefine inherited attributes and operations.
- **Messages** - Procedures in separate objects communicate (i.e., call and return) via messages.

How to Identify Objects

Identifying Objects

Object Name

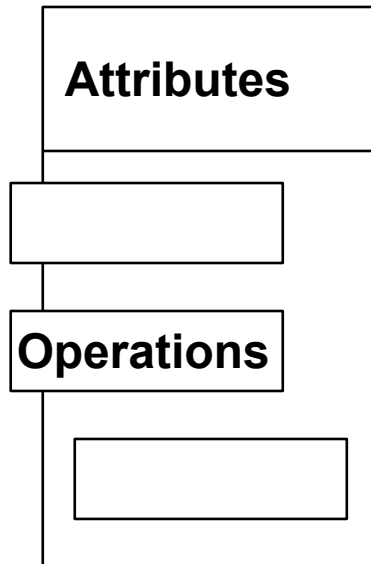

Potential Objects - examples

- External entities - devices, people
- Things - reports, displays, signals
- Occurances or events - interrupts
- Roles - manager, engineer
- Organizational units - division, group
- Places - shop floor, tail section
- Structures - sensors, computers

Identifying Objects - Example

Find the potential objects in the following narrative:

***Safehome* software enables the homeowner to configure the security system when it is installed, monitors all sensors connected to the security system, and interacts with the homeowner through a key pad and function keys contained in the *SafeHome* control panel.**

During installation, the *SafeHome* control panel is used to "program" and configure the system. Each sensor is assigned a number and type, a master password is programmed for arming and disarming the system, and telephone number(s) is (are) input for dialing when a sensor event occurs.

When a sensor event is sensed by the software, it rings an audible alarm attached to the system. After a delay time that is specified by the homeowner during system configuration activities, the software dials a telephone number of a monitoring service, provides information about the location, and reports the nature of the event that has been detected. The number will be redialed every 20 seconds until telephone connection is obtained.

Identifying Objects - Example

Selection Criteria for classes and objects:

1. Retained information - information that must be remembered for system to function.
2. Needed services - operation are needed to change values of attributes.
3. Multiple attributes - focus on "major" information. Single or minor attributes can be collected together in single object.
4. Common attributes - attributes which apply to all occurrences of the object.
5. Common operations - operations which apply to all occurrences of the object.
6. Essential requirements - external entities that produce or consume information that is essential to system operation.

How to Identify Objects

Specifying Attributes

1. Scan the problem definition and select those things that belong to an object.
2. For each object, ask "what data items (composite or elementary) fully define this object in the context of the problem?"
3. For example, using the *SafeHome* system object:

**sensor_info = sensor_type + sensor_number +
alarm_threshold**

**alarm_response = delay_time + telephone_number +
alarm_type**

**activate/deactivate_info = master_password +
tries_allowed + temp_password**

**id_info = system_ID + verification_phone_no. +
system_status**

How to Identify Objects

Defining Operations

Operations are of three types:

- **Manipulation - add, delete, reformat, select, initialize**
- **Computation - equations, transformations**
- **Monitoring - occurrence of a controlling event**

To derive a set of operations for each object:

- 1. Scan the problem definition and grammatically parse it for verbs to be candidate operations that belong to each object.**
- 2. Try defining the candidate operations for objects defining the SafeHome system (use description in prior slide)**

How to Identify Objects

Interobject Communication

During requirements definition, explicit messages need not be known. Only general object interaction should be defined.

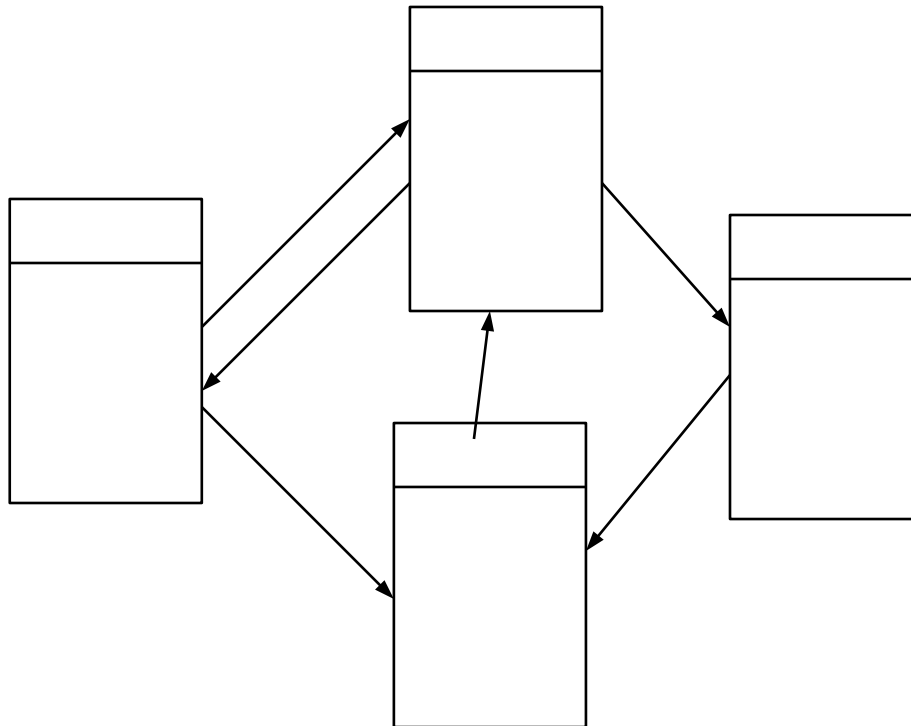

Note: Messages initiated by procedures in objects, and are sent to procedures in objects.

msg: (dest, op, args)

Object-Oriented Development Process

Given a clear and complete statement of problem definition:

Identify
Objects

Identify
Structures

Define
Subjects

Define Attributes
and instance
connections

Define Operations
and Message
Connections

Coad, P., and E. Yourdon, *Object Oriented Analysis*,
Prentice-Hall, 1990.

OOA Modeling

Classification and Assembly Structures

Once objects have been defined, structure groups of them into classification trees or assembly trees:

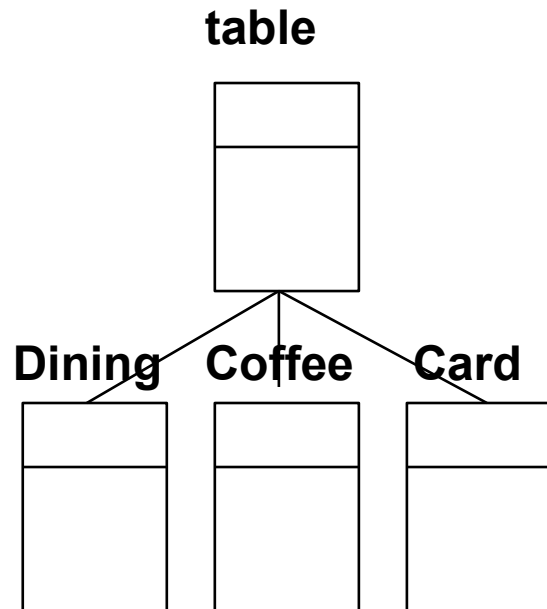

Classification Structure

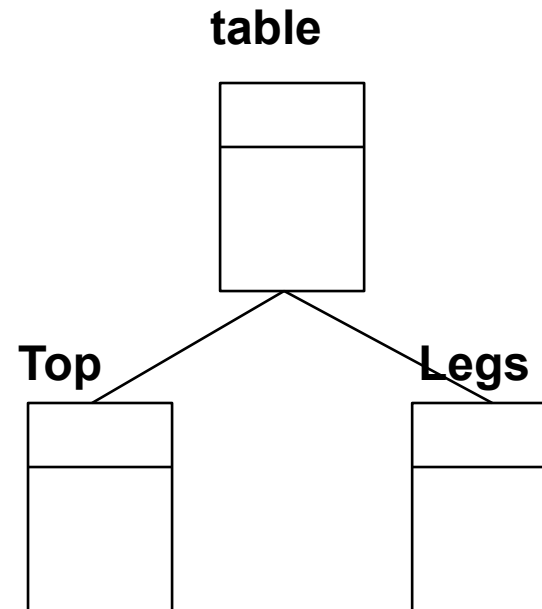

Assembly Structure

Object-Oriented Development Process

Given a clear and complete statement of problem definition:

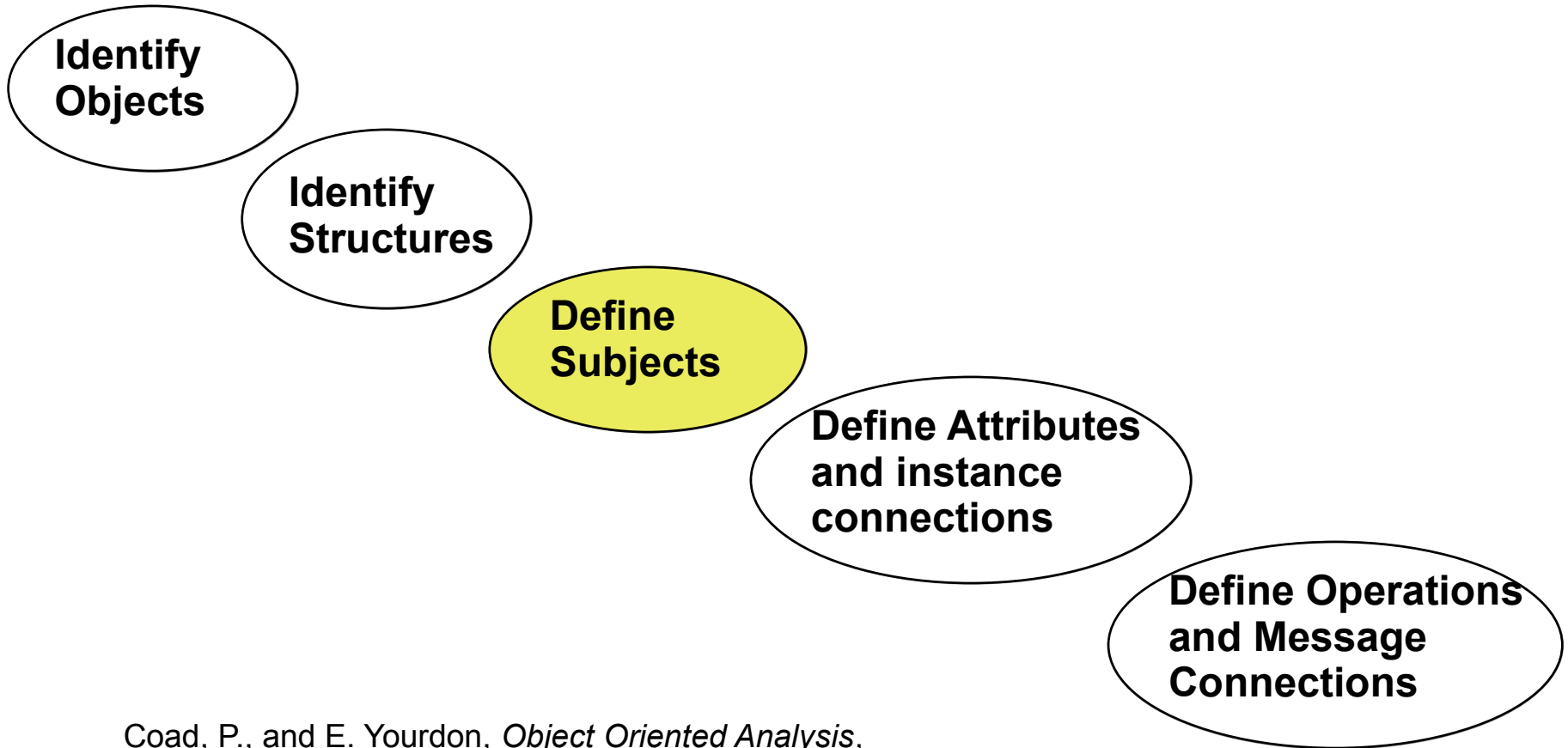

Coad, P., and E. Yourdon, *Object Oriented Analysis*,
Prentice-Hall, 1990.

OOA Modeling

Defining Subjects

For large OOA models with hundreds of objects and dozens of structures, organize the structures in to subjects which can be referenced by a single name or ID.

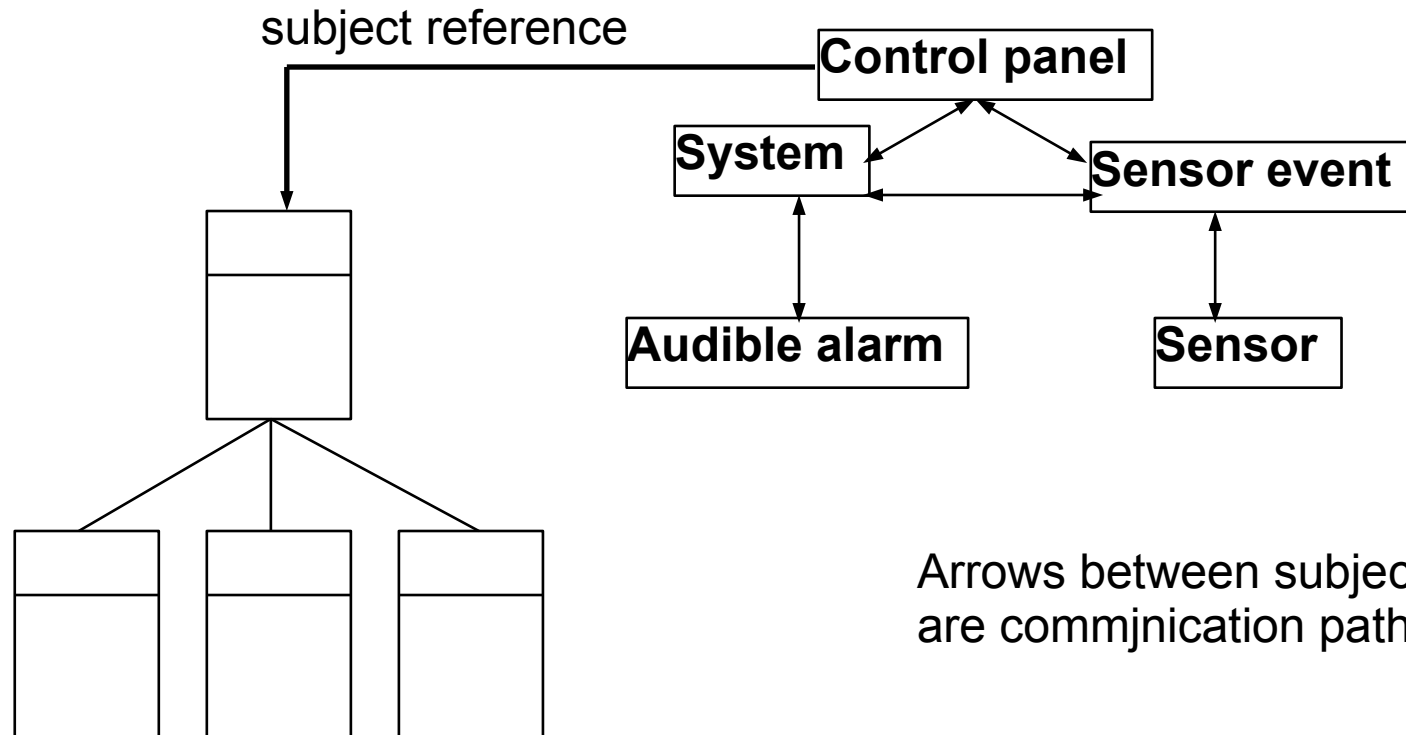

Object-Oriented Development Process

Given a clear and complete statement of problem definition:

Identify
Objects

Identify
Structures

Define
Subjects

Define Attributes
and instance
connections

Define Operations
and Message
Connections

Coad, P., and E. Yourdon, *Object Oriented Analysis*,
Prentice-Hall, 1990.

OOA Modeling

Instance Connections and Message Paths

Analyst should define specific relationships between objects:

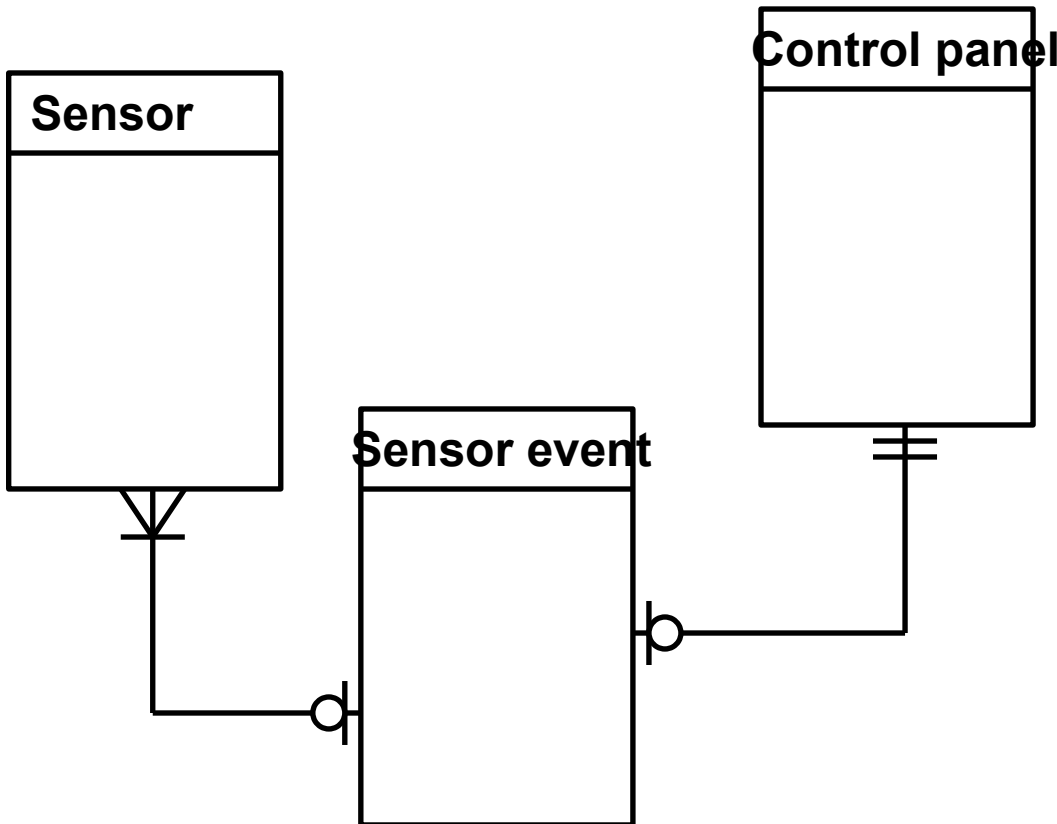

Define:

○ zero

| one

< many

Thus:

—○| zero or one

—|| exactly one

—|/ one or more

—○/ zero or more

OOA Modeling

Prototyping

OOA can lead to very effective prototyping techniques

- Reuse defined, coded, and tested objects**
- Establish library of quality objects and save analysis info as well as code and tested objects**
- Use existing object specifications in the development of new products.**